

▶ BCE742220B
BCK742220M

EN User Manual
Oven

USER MANUAL



AEG

CONTENTS

1. SAFETY INFORMATION.....	2
2. SAFETY INSTRUCTIONS.....	4
3. PRODUCT DESCRIPTION.....	7
4. CONTROL PANEL.....	8
5. BEFORE FIRST USE.....	10
6. DAILY USE.....	10
7. CLOCK FUNCTIONS.....	16
8. AUTOMATIC PROGRAMMES.....	17
9. USING THE ACCESSORIES.....	17
10. ADDITIONAL FUNCTIONS.....	20
11. HINTS AND TIPS.....	21
12. CARE AND CLEANING.....	38
13. TROUBLESHOOTING.....	41
14. ENERGY EFFICIENCY.....	43

FOR PERFECT RESULTS

Thank you for choosing this AEG product. We have created it to give you impeccable performance for many years, with innovative technologies that help make life simpler - features you might not find on ordinary appliances. Please spend a few minutes reading to get the very best from it.

Visit our website for:



Get usage advice, brochures, trouble shooter, service information:

www.aeg.com/webselfservice



Register your product for better service:

www.registeraeg.com



Buy Accessories, Consumables and Original spare parts for your appliance:

www.aeg.com/shop

CUSTOMER CARE AND SERVICE

Always use original spare parts.

When contacting our Authorised Service Centre, ensure that you have the following data available: Model, PNC, Serial Number.

The information can be found on the rating plate.

 Warning / Caution-Safety information

 General information and tips

 Environmental information

Subject to change without notice.

1. SAFETY INFORMATION

Before the installation and use of the appliance, carefully read the supplied instructions. The

manufacturer is not responsible for any injuries or damage that are the result of incorrect installation or usage. Always keep the instructions in a safe and accessible location for future reference.

1.1 Children and vulnerable people safety

- This appliance can be used by children aged from 8 years and above and persons with reduced physical, sensory or mental capabilities or lack of experience and knowledge if they have been given supervision or instruction concerning the use of the appliance in a safe way and understand the hazards involved.
- Children between 3 and 8 years of age and persons with very extensive and complex disabilities shall be kept away from the appliance unless continuously supervised.
- Children of less than 3 years of age should be kept away from the appliance unless continuously supervised.
- Do not let children play with the appliance.
- Keep all packaging away from children and dispose of it appropriately.
- Keep children and pets away from the appliance when it operates or when it cools down. Accessible parts may become hot during use.
- If the appliance has a child safety device, it should be activated.
- Children shall not carry out cleaning and user maintenance of the appliance without supervision.

1.2 General Safety

- Only a qualified person must install this appliance and replace the cable.
- **WARNING:** The appliance and its accessible parts become hot during use. Care should be taken to avoid touching heating elements.
- Always use oven gloves to remove or put in accessories or ovenware.

- Before carrying out any maintenance, disconnect the appliance from the power supply.
- **WARNING:** Ensure that the appliance is switched off before replacing the lamp to avoid the possibility of electric shock.
- Do not use the appliance before installing it in the built-in structure.
- Do not use a steam cleaner to clean the appliance.
- Do not use harsh abrasive cleaners or sharp metal scrapers to clean the glass door since they can scratch the surface, which may result in shattering of the glass.
- If the mains power supply cable is damaged, it must be replaced by the manufacturer, its Authorised Service Centre or similarly qualified persons to avoid an electrical hazard.
- To remove the shelf supports first pull the front of the shelf support and then the rear end away from the side walls. Install the shelf supports in the opposite sequence.
- Use only the food sensor (core temperature sensor) recommended for this appliance.

2. SAFETY INSTRUCTIONS

2.1 Installation



WARNING!

Only a qualified person must install this appliance.

- Remove all the packaging.
- Do not install or use a damaged appliance.
- Follow the installation instructions supplied with the appliance.
- Always take care when moving the appliance as it is heavy. Always use safety gloves and enclosed footwear.
- Do not pull the appliance by the handle.
- Install the appliance in a safe and suitable place that meets installation requirements.
- Keep the minimum distance from other appliances and units.
- Before mounting the appliance, check if the oven door opens without restraint.
- The appliance is equipped with an electric cooling system. It must be operated with the electric power supply.
- The built-in unit must meet the stability requirements of DIN 68930.

Cabinet minimum height (Cabinet under the worktop minimum height)	600 (600) mm
Cabinet width	550 mm
Cabinet depth	605 (580) mm
Height of the front of the appliance	594 mm

Height of the back of the appliance	576 mm
Width of the front of the appliance	549 mm
Width of the back of the appliance	548 mm
Depth of the appliance	567 mm
Built in depth of the appliance	546 mm
Depth with open door	1017 mm
Ventilation opening minimum size. Opening placed on the bottom rear side	550 x 20 mm
Mains supply cable length. Cable is placed in the right corner of the back side	1500 mm
Mounting screws	4 x 12 mm

2.2 Electrical connection



WARNING!

Risk of fire and electric shock.

- All electrical connections should be made by a qualified electrician.
- The appliance must be earthed.
- Make sure that the parameters on the rating plate are compatible with the electrical ratings of the mains power supply.
- Always use a correctly installed shockproof socket.
- Do not use multi-plug adapters and extension cables.
- Make sure not to cause damage to the mains plug and to the mains cable. Should the mains cable need to be replaced, this must be carried out by our Authorised Service Centre.
- Do not let mains cables touch or come near the appliance door or the

niche below the appliance, especially when it operates or the door is hot.

- The shock protection of live and insulated parts must be fastened in such a way that it cannot be removed without tools.
- Connect the mains plug to the mains socket only at the end of the installation. Make sure that there is access to the mains plug after the installation.
- If the mains socket is loose, do not connect the mains plug.
- Do not pull the mains cable to disconnect the appliance. Always pull the mains plug.
- Use only correct isolation devices: line protecting cut-outs, fuses (screw type fuses removed from the holder), earth leakage trips and contactors.
- The electrical installation must have an isolation device which lets you disconnect the appliance from the mains at all poles. The isolation device must have a contact opening width of minimum 3 mm.
- This appliance is supplied with a main plug and a main cable.

2.3 Use



WARNING!

Risk of injury, burns and electric shock or explosion.

- This appliance is for household use only.
- Do not change the specification of this appliance.
- Make sure that the ventilation openings are not blocked.
- Do not let the appliance stay unattended during operation.
- Deactivate the appliance after each use.
- Be careful when you open the appliance door while the appliance is in operation. Hot air can release.
- Do not operate the appliance with wet hands or when it has contact with water.
- Do not apply pressure on the open door.
- Do not use the appliance as a work surface or as a storage surface.

- Open the appliance door carefully. The use of ingredients with alcohol can cause a mixture of alcohol and air.
- Do not let sparks or open flames to come in contact with the appliance when you open the door.
- Do not put flammable products or items that are wet with flammable products in, near or on the appliance.

**WARNING!**

Risk of damage to the appliance.

- To prevent damage or discoloration to the enamel:
 - do not put ovenware or other objects in the appliance directly on the bottom.
 - do not put aluminium foil directly on the bottom of cavity of the appliance.
 - do not put water directly into the hot appliance.
 - do not keep moist dishes and food in the appliance after you finish the cooking.
 - be careful when you remove or install the accessories.
- Discoloration of the enamel or stainless steel has no effect on the performance of the appliance.
- Use a deep pan for moist cakes. Fruit juices cause stains that can be permanent.
- This appliance is for cooking purposes only. It must not be used for other purposes, for example room heating.
- Always cook with the oven door closed.
- If the appliance is installed behind a furniture panel (e.g. a door) make sure the door is never closed when the appliance is in operation. Heat and moisture can build up behind a closed furniture panel and cause subsequent damage to the appliance, the housing unit or the floor. Do not close the furniture panel until the appliance has cooled down completely after use.

2.4 Care and cleaning

**WARNING!**

Risk of injury, fire, or damage to the appliance.

- Before maintenance, deactivate the appliance and disconnect the mains plug from the mains socket.
- Make sure the appliance is cold. There is the risk that the glass panels can break.
- Replace immediately the door glass panels when they are damaged. Contact the Authorised Service Centre.
- Be careful when you remove the door from the appliance. The door is heavy!
- Clean regularly the appliance to prevent the deterioration of the surface material.
- Clean the appliance with a moist soft cloth. Use only neutral detergents. Do not use abrasive products, abrasive cleaning pads, solvents or metal objects.
- If you use an oven spray, follow the safety instruction on it's packaging.
- Do not clean the catalytic enamel (if applicable) with detergents.

2.5 Internal lighting

**WARNING!**

Risk of electric shock.

- The type of light bulb or halogen lamp used for this appliance is for household appliances only. Do not use it for house lighting.
- Before replacing the lamp, disconnect the appliance from the power supply.
- Use only lamps with the same specifications.

2.6 Service

- To repair the appliance contact the Authorised Service Centre.
- Use original spare parts only.

2.7 Disposal

**WARNING!**

Risk of injury or suffocation.

- Disconnect the appliance from the mains supply.
- Cut off the mains electrical cable close to the appliance and dispose of it.

- Remove the door catch to prevent children or pets from becoming trapped in the appliance.

3. PRODUCT DESCRIPTION

3.1 General overview

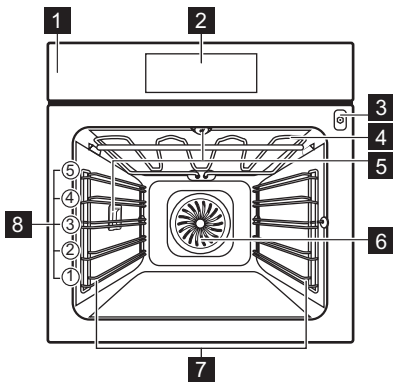

- 1 Control panel
- 2 Electronic programmer
- 3 Socket for the core temperature sensor
- 4 Heating element
- 5 Lamp
- 6 Fan
- 7 Shelf support, removable
- 8 Shelf positions

3.2 Accessories

Wire shelf

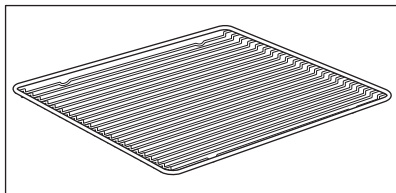

For cookware, cake tins, roasts.

Baking tray

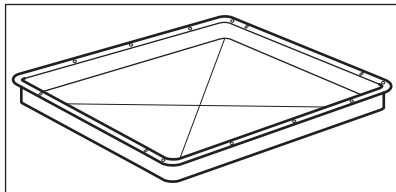

For cakes and biscuits.

Grill- / Roasting pan

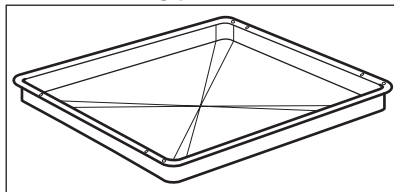

To bake and roast or as a pan to collect fat.

Food Sensor

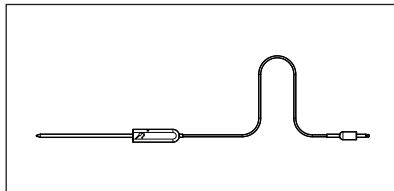







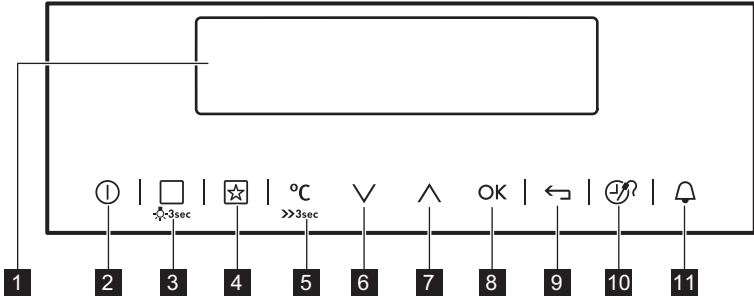

To measure the temperature inside food.



4. CONTROL PANEL

4.1 Electronic programmer



Use the sensor fields to operate the appliance.

Sensor field	Function	Comment
1	-	Display Shows the current settings of the oven.
2	 ON / OFF	To turn the oven on and off.
3	 Heating Functions or Assisted Cooking	Press the sensor field once to choose a heating function or the menu: Assisted Cooking. Press the sensor field again to switch between the menus: Heating Functions, Assisted Cooking. To turn on or turn off the light, press the field for 3 seconds. You can turn on the light also when the oven is off.
4	 Favourites	To save and access your favourite programmes.
5	 Temperature selection	To set the temperature or show the current temperature in the oven. Press the field for 3 seconds to turn on or turn off the function: Fast Heat Up.
6	 Down key	To move down in the menu.
7	 Up key	To move up in the menu.
8	 OK	To confirm the selection or setting.
9	 Back key	To go back one level in the menu. To show the main menu, press the field for 3 seconds.





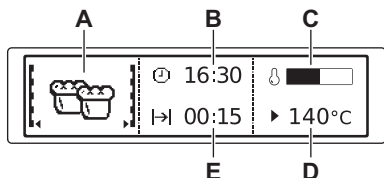







Sensor field	Function	Comment
10 	Time and additional functions	To set different functions. When a heating function works, press the sensor field to set the timer or the functions: Function Lock, Favourites, Heat + Hold, Set + Go. You can also change the settings of the core temperature sensor.
11 	Minute Minder	To set the function: Minute Minder.

4.2 Display



- A. Heating function
- B. Time of day
- C. Heat-up indicator
- D. Temperature
- E. Duration time or end time of a function

Other indicators of the display:

Symbol	Function	Function
	Minute Minder	The function works.
	Time of day	The display shows the current time.
	Duration	The display shows the necessary time for cooking.
	End Time	The display shows when the cooking time is complete.
	Temperature	The display shows the temperature.
	Time Indication	The display shows how long the heating function works. Press  and  at the same time to reset the time.
	Calculation	The oven calculates the time for cooking.
	Heat-up Indicator	The display shows the temperature in the oven.
	Fast Heat Up	The function is on. It decreases the heat up time.
	Weight Automatic	The display shows that the automatic weight system is on or that weight can be changed.

Symbol	Function
 Heat + Hold	The function is on.

5. BEFORE FIRST USE



WARNING!
Refer to Safety chapters.

5.1 Initial Cleaning

Remove all accessories and removable shelf supports from the oven.

Refer to "Care and cleaning" chapter.

Clean the oven and the accessories before the first use.

Put the accessories and the removable shelf supports back to their initial position.

5.2 First Connection

When you connect the oven to the mains or after the power cut, you have to set the language, the display contrast, the display brightness and the time of the day.



1. Press  or  to set the value.
2. Press **OK** to confirm.

6. DAILY USE



WARNING!
Refer to Safety chapters.

6.1 Navigating the menus



1. Turn on the oven.
2. Press  or  to select the menu option.
3. Press **OK** to move to the submenu or accept the setting.







At each point you can go back to the main menu with .

6.2 The menus in overview









Main menu







Symbol / Menu item	Application
 Heating Functions	Contains a list of heating functions.
 Recipes	Contains a list of automatic programmes.

Symbol / Menu item	Application
 Favourites	Contains a list of favourite cooking programmes created by the user.
 Catalysis	Catalytic cleaning.
 Basic Settings	Used to set the appliance configuration.
 Specials	Contains a list of additional heating functions.



Symbol / Menu item	Application
 Assisted Cooking	Contains recommended oven settings for a wide choice of dishes. Select a dish and start the cooking process. The temperature and time are only guidelines for a better result and can be adjusted. They depend on the recipes and the quality and quantity of the used ingredients.





Submenu for: Basic Settings

Symbol / Menu item	Description
 Set Time of Day	Sets the current time on the clock.
 Time Indication	When ON, the display shows the current time when you deactivate the appliance.
 Fast Heat Up	When ON, the function decreases the heat-up time.
 Set + Go	To set a function and activate it later with a press of any symbol on the control panel.
 Heat + Hold	Keeps the prepared food warm for 30 minutes after a cooking cycle finished.
 Time Extension	Activates and deactivates the time extension function.
 Display Contrast	Adjusts the display contrast by degrees.
 Display Brightness	Adjusts the display brightness by degrees.

Symbol / Menu item	Description
 Set Language	Sets the language for the display.
 Buzzer Volume	Adjusts the volume of press-tones and signals by degrees.
 Key Tones	Activates and deactivates the tone of the touch fields. It is not possible to deactivate the tone of the ON / OFF touch field.
 Alarm/Error Tones	Activates and deactivates the alarm tones.
 DEMO mode	Activation / deactivation code: 2468.
 Service	Shows the software version and configuration.
 Factory Settings	Resets all settings to factory settings.

6.3 Heating Functions

Heating function	Application
 True Fan Cooking	To bake on up to three shelf positions at the same time and to dry food. Set the temperature 20 - 40 °C lower than for the function: Conventional Cooking.
 Pizza Function	To bake food on one shelf position for a more intensive browning and a crispy bottom. Set the temperature 20 - 40 °C lower than for the function: Conventional Cooking.









Heating function	Application
 Conventional Cooking	To bake and roast food on one shelf position.
 Frozen Foods	To make convenience food (e.g. french fries, potato wedges or spring rolls) crispy.
 Grill	To grill flat food and to toast bread.
 Turbo Grilling	To roast larger meat joints or poultry with bones on one shelf position. To make gratins and to brown.
 Bottom Heat	To bake cakes with crispy bottom and to preserve food.

Heating function	Application
 Moist Fan Baking	<p>This function is designed to save energy during cooking. For the cooking instructions refer to "Hints and tips" chapter, Moist Fan Baking. The oven door should be closed during cooking so that the function is not interrupted and to ensure that the oven operates with the highest energy efficiency possible. When you use this function, the temperature in the cavity may differ from the set temperature. The residual heat is used. The heating power may be reduced. For general energy saving recommendations refer to "Energy Efficiency" chapter, Energy Saving. This function was used to comply with the energy efficiency class according to EN 60350-1. When you use this function the lamp automatically turns off after 30 seconds.</p>

 The lamp may automatically deactivate at a temperature below 60 °C during some oven functions.

6.4 Specials

Heating function	Application
 Keep Warm	To keep food warm.

Heating function	Application
 Plate Warming	To preheat plates for serving.
 Preserving	To make vegetable preserves (e.g. pickles).
 Dehydrating	To dry sliced fruit, vegetables and mushrooms.
 Dough Proving	To speed up the rising of the yeast dough. It prevents dough surface from drying and keeps the dough elastic.
 Slow Cooking	To prepare tender, succulent roasts.
  Bread Baking	Use this function to prepare bread and bread rolls with a very good professional-like result in terms of crispness, colour and crust gloss.
 Defrost	To defrost food (vegetables and fruit). The defrosting time depends on the amount and size of the frozen food.
 Au Gratin	For dishes such as lasagna or potato gratin. To make gratins and to brown.

6.5 Assisted Cooking





Food Category: Fish / Seafood







Dish	
Fish	Fish, baked
	Fish fingers
	Fish fillet, frozen
	Whole small fish, grilled
	Whole fish, grilled
	Whole fish, grilled 
Whole salmon	-

Food Category: Poultry

Dish	
Boned poultry	-
Chicken	Chicken wings, fresh
	Chicken wings, frozen
	Chicken legs, fresh
	Chicken legs, frozen
	Chicken, 2 halves

Food Category: Meat

Dish	
Beef	Braised meat 
	Meatloaf
Roast beef	Rare
	Rare 
	Medium
	Medium 
	Well done
	Well done 

Dish	
Scandinavian beef	Rare 
	Medium 
	Well done 
Pork	Spare ribs
	Pork knuckle, pre-cooked
	Pork joint
	Loin of pork
	Pork neck
	Pork shoulder
	Veal
Loin of veal	
Roast veal 	
Lamb	Leg of lamb
	Saddle of lamb
	Lamb joint, medium
Game	Hare <ul style="list-style-type: none"> • Leg of hare • Saddle of hare
	Venison <ul style="list-style-type: none"> • Haunch of venison • Saddle of venison
	Roast game 
	Loin of game 

Food Category: Oven Dishes

Dish	
Lasagne / Cannelloni, frozen	-
Vegetables au gratin	-

Dish	
Sweet dishes	-

Food Category: Pizza / Quiche

Dish	
Pizza	Pizza, thin
	Pizza, extra topping
	Pizza, frozen
	Pizza American, frozen
	Pizza, chilled
	Pizza snacks, frozen
Baguettes au gratin	-
Tarte flambée	-
Swiss Tarte, savoury	-
Quiche lorraine	-
Savory flan	-

Food Category: Cake / Pastry

Dish	
Ring cake	-
Apple cake, covered	-
Sponge cake	-
Apple pie	-
Cheese cake, tin	-
Brioche	-
Madeira cake	-
Tarte	-
Swiss Tarte, sweet	-
Almond cake	-
Muffins	-
Pastry	-
Pastry strips	-

Dish	
Cream puffs	-
Puff pastry	-
Eclairs	-
Macaroons	-
Short pastry biscuits	-
Christmas stollen	-
Apple strudel, frozen	-
Cake on tray	Sponge dough
	Yeast dough
Cheese cake, tray	-
Brownies	-
Swiss roll	-
Yeast cake	-
Crumble cake	-
Sugar cake	-
Flan base	Short pastry flan base
	Sponge mixture flan base
Fruit flan	Short pastry fruit flan
	Sponge mixture fruit flan
	Yeast dough

Food Category: Bread / Rolls

Dish	
Rolls	Rolls, frozen
Ciabatta	-
Bread	Bread crown
	Yeast plait
	Unleavened bread

Food Category: Side dishes

Dish	
French fries, thin	-
French fries, thick	-
French fries, frozen	-
Croquettes	-
Wedges	-
Hash browns	-



When it is necessary to change the weight or the core temperature of the dish, use \wedge or \vee to set the new values.

6.6 Setting a heating function

1. Turn on the oven.
2. Select the menu: Heating Functions.
3. Press **OK** to confirm.
4. Select a heating function.
5. Press **OK** to confirm.
6. Set the temperature.
7. Press **OK** to confirm.

6.7 Heat-up indicator

When you turn on a heating function, the bar on the display comes on. The bar shows that the temperature increases. When temperature is reached the buzzer sounds 3 times and the bar flashes and then disappears.

6.8 Fast Heat Up

This function decreases the heat-up time.



Do not put food in the oven when the Fast heat up function works.

To turn on the function, hold $\gg_{\text{min}}^{\circ\text{C}}$ for 3 seconds. The heat-up indicator alternates.







This function is not available for some oven functions.

6.9 Residual heat

When you turn off the oven, the display shows the residual heat. You can use the heat to keep the food warm.

7. CLOCK FUNCTIONS

7.1 Clock functions table

Clock function	Application
 Minute Minder	To set a countdown (max. 2 h 30 min). This function has no effect on the operation of the oven. You can also turn it on when the oven is turned off. Use  to turn on the function. Press  or  to set the minutes and OK to start.
 Duration	To set how long the oven works (max. 23 h 59 min).
 End Time	To set the switch-off time for a heating function (max. 23 h 59 min).

If you set the time for a clock function, the time starts to count down after 5 seconds.



If you use the clock functions: Duration, End Time, the oven turns off the heating elements after 90 % of the set time. The oven uses the residual heat to continue the cooking process until the time ends (3 - 20 minutes).



7.2 Setting the clock functions



Before you use the functions: Duration, End Time, you must set a heating function and temperature first. The oven turns off automatically.

You can use the functions: Duration and End Time at the same time if you want to automatically turn on and turn off the oven on a given time later.

The functions: Duration and End Time do not work when you use the core temperature sensor.

1. Set a heating function.
2. Press  again and again until the display shows the necessary clock function and the related symbol.
3. Press  or  to set the necessary time.
4. Press **OK** to confirm.
When the time ends, a signal sounds. The oven turns off. The display shows a message.
5. Press any symbol to stop the signal.

7.3 Heat + Hold

Conditions for the function:

- The set temperature is more than 80 °C.
- The function: Duration is set.

The function: Heat + Hold keeps prepared food warm at 80 °C for 30 minutes. It turns on after the baking or roasting procedure ends.

You can turn on or turn off the function in the menu: Basic Settings.

1. Turn on the oven.
2. Select the heating function.



3. Set the temperature above 80 °C.
 4. Press  again and again until the display shows: Heat + Hold.
 5. Press **OK** to confirm.
- When the function ends, a signal sounds.

7.4 Time Extension

The function: Time Extension makes the heating function continue after the end of Duration.



Applicable to all heating functions with Duration or Weight Automatic.
Not applicable to heating functions with the core temperature sensor.

1. When the cooking time ends, a signal sounds. Press any symbol. The display shows the message.
2. Press  to turn on or  to cancel.
3. Set the length of the function.
4. Press **OK**.

8. AUTOMATIC PROGRAMMES



WARNING!
Refer to Safety chapters.

8.1 Recipes online

You can find the recipes for the automatic programmes on our website. To find the Recipe Book check the PNC number on the rating plate on the front frame of the oven cavity.

8.2 Recipes with Recipe Automatic

This oven has a set of recipes you can use. The recipes are fixed and you cannot change them.

1. Turn on the oven.
2. Select the menu: Recipes. Press **OK** to confirm.
3. Select the category and dish. Press **OK** to confirm.
4. Select a recipe. Press **OK** to confirm.

9. USING THE ACCESSORIES



WARNING!
Refer to Safety chapters.

9.1 Food sensor

The food sensor measures temperature inside the food. When the food is at the set temperature, the appliance deactivates.

There are two temperatures to be set:

- the oven temperature (minimum 120 °C),
- the food core temperature.



CAUTION!
Use only the food sensor supplied and the original replacement parts.

Directions for the best results:

- Ingredients should be at room temperature.
- Food sensor cannot be used for liquid dishes.
- During cooking the food sensor must remain in the dish and the plug in the socket.
- Use recommended food core temperature settings. Refer to "Hints and tips" chapter.



The appliance calculates an approximate end of cooking time. It depends on the quantity of food, the set oven function and temperature.

Food categories: meat, poultry and fish

1. Activate the appliance.
2. Insert the tip of the food sensor into the centre of meat or fish, in the thickest part if possible. Make sure that at least 3/4 of the food sensor is inside of the dish.
3. Put the plug of the food sensor into the socket located in the front frame of the appliance.

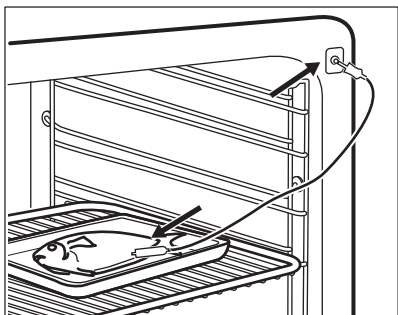
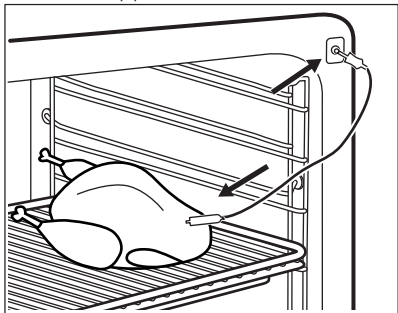

The display shows the food sensor symbol.

4. Press \wedge or \vee in less than 5 seconds to set the food core temperature.
5. Set a heating function and, if necessary, the oven temperature.
6. To change the food core temperature, press ⌚ .

When the dish reaches the set temperature, an acoustic signal sounds. The appliance deactivates automatically.

7. Touch any symbol to stop the signal.
8. Remove the food sensor plug from the socket and remove the dish from the appliance.



WARNING!

There is a risk of burns as the food sensor becomes hot. Be careful when you unplug it and remove it from the food.

Food category: casserole

1. Activate the appliance.
2. Place half of the ingredients in a baking dish.
3. Insert the tip of the food sensor exactly in the centre of the casserole. The food sensor should be stabilized in one place during baking. Use a solid ingredient to achieve that. Use the rim of the baking dish to support the silicone handle of the food sensor. The tip of the food sensor should not touch the bottom of a baking dish.

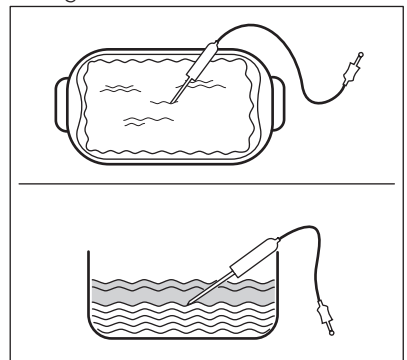

4. Cover the food sensor with the remaining ingredients.
5. Put the plug of the food sensor into the socket located in the front frame of the appliance.

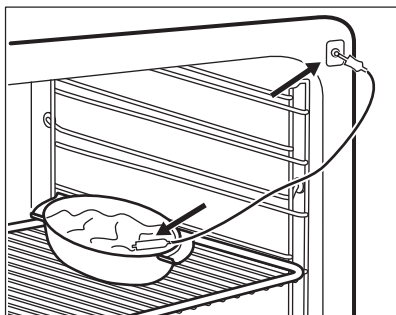

The display shows the food sensor symbol.

6. Press \wedge or \vee in less than 5 seconds to set the food core temperature.
7. Set a heating function and, if necessary, the oven temperature.
8. To change the food core temperature, press Ⓢ .

When the dish is at the set temperature, an acoustic signal sounds. The appliance deactivates automatically.

9. Touch any symbol to stop the signal.
10. Remove the food sensor plug from the socket and remove the dish from the appliance.



WARNING!

There is a risk of burns as the food sensor becomes hot. Be careful when you unplug it and remove it from the food.

9.2 Inserting the accessories

Wire shelf:

Push the shelf between the guide bars of the shelf support .

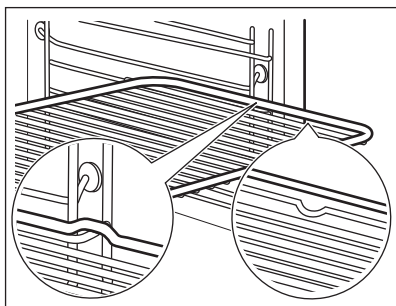

Baking tray/ Deep pan:

Push the baking tray / deep pan between the guide bars of the shelf support.

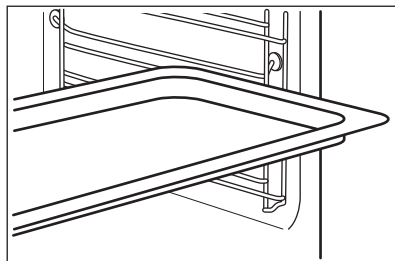

Wire shelf and baking tray / deep pan together:

Push the baking tray / deep pan between the guide bars of the shelf support and the wire shelf on the guide bars above.

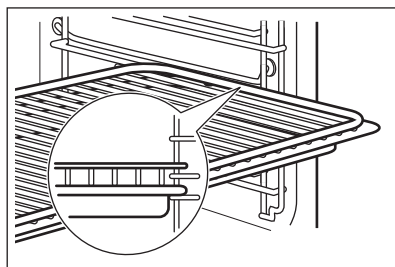



Small indentation at the top increase safety. The indentations are also anti-tip devices. The high rim around the shelf prevents cookware from slipping of the shelf.



10. ADDITIONAL FUNCTIONS

10.1 Favourites

You can save your favourite settings, such as duration, temperature or heating function. They are available in the menu: Favourites. You can save 20 programmes.

Saving a programme

1. Turn on the oven.
2. Set a heating function or an automatic programme.
3. Press  again and again until the display shows: SAVE.
4. Press **OK** to confirm.
The display shows the first free memory position.
5. Press **OK** to confirm.
6. Enter the name of the programme.
The first letter flashes.
7. Press  or  to change the letter.
8. Press **OK**.
The next letter flashes.
9. Do step 7 again as necessary.

10. Press and hold **OK** to save.
You can overwrite a memory position. When the display shows the first free memory position, press  or  and press **OK** to overwrite an existing programme.

You can change the name of a programme in the menu: Edit Programme Name.



Activating the programme

1. Turn on the oven.
2. Select the menu: Favourites.
3. Press **OK** to confirm.
4. Select your favourite programme name.
5. Press **OK** to confirm.

You can press  to go directly to menu: Favourites. You can also use it when the oven is off.

10.2 Using the Child Lock



When the Child Lock is on, the oven cannot be turned on accidentally.

1. Press  to turn on the display.
2. Press  and  at the same time until the display shows a message .
To turn off the Child Lock function repeat step 2.

10.3 Function Lock

This function prevents an accidental change of the heating function. You can turn it on only when the oven works.

1. Turn on the oven.
2. Set a heating function or setting.
3. Press  again and again until the display shows: Function Lock.
4. Press **OK** to confirm.



To turn off the function, press . The display shows a message. Press  again and then **OK** to confirm.



When you turn off the oven, the function also turns off.

10.4 Set + Go

The function lets you set a heating function (or a programme) and use it later with one press of any symbol.

1. Turn on the oven.
2. Set a heating function.
3. Press  again and again until the display shows: Duration.
4. Set the time.
5. Press  again and again until the display shows: Set + Go.
6. Press **OK** to confirm.

Press any symbol (except for ) to start the function: Set + Go. The set heating function starts.

When the heating function ends, a signal sounds.



- Function Lock is on when the heating function works.
- The menu: Basic Settings lets you turn the function: Set + Go on and off.

10.5 Automatic Switch-Off

For safety reasons the oven turns off automatically after some time, if a heating function works and you do not change any settings.

(°C)	(h)
30 - 115	12.5
120 - 195	8.5
200 - 245	5.5
250 - maximum	3

The Automatic Switch-off does not work with the functions: Light, Food Sensor, Duration, End Time.

10.6 Brightness of the display

There are two modes of display brightness:

- Night brightness - when the oven is turned off, the brightness of the display is lower between 10 PM and 6 AM.
- Day brightness:
 - when the oven is turned on.
 - if you touch a symbol during the night brightness (apart from ON / OFF), the display goes back to the day brightness mode for the next 10 seconds.
 - if the oven is turned off and you set the function: Minute Minder. When the function ends, the display goes back to the night brightness.

10.7 Cooling fan

When the oven operates, the cooling fan turns on automatically to keep the surfaces of the oven cool. If you turn off the oven, the cooling fan can continue to operate until the oven cools down.

11. HINTS AND TIPS



WARNING!
Refer to Safety chapters.



The temperature and baking times in the tables are guidelines only. They depend on the recipes and the quality and quantity of the ingredients used.

11.1 Cooking recommendations

Your oven may bake or roast differently to the oven you had before. The tables below show recommended settings for temperature, cooking time and shelf position for specific types of the food.

If you cannot find the settings for a special recipe, look for the similar one.

11.2 Inner side of the door

On the inner side of the door you can find:

- the numbers of the shelf positions.
- information about the heating functions, recommended shelf positions and temperatures for dishes.

11.3 Advice for special heating functions of the oven

Keep Warm

The function allows you to keep food warm. The temperature is set automatically to 80 °C.

Plate Warming

The function allows you to warm plates and dishes before serving. The temperature is set automatically to 70 °C.

Place plates and dishes in stacks evenly on the wire shelf. Use the first shelf position. After half of the warming time switch their places.

Dough Proving

The function allows you to rise yeast dough. Put the dough into a big dish and cover it with a wet towel or plastic foil. Set function: Dough Proving and the cooking time.

Defrost

Remove the food packaging and put the food on a plate. Do not cover the food,

as it can extend the defrosting time. Use the first shelf position.

11.4 Baking

Use the lower temperature the first time.

You can extend baking times by 10 – 15 minutes if you bake cakes on more than one shelf position.







Cakes and pastries at different heights do not always brown equally. There is no need to change the temperature setting if an unequal browning occurs. The differences equalize during baking.







Trays in the oven can twist during baking. When the trays become cold again, the distortions disappear.







11.5 Tips on baking







Baking results	Possible cause	Remedy
The bottom of the cake is not baked sufficiently.	The shelf position is incorrect.	Put the cake on a lower shelf.
The cake sinks and becomes soggy or streaky.	The oven temperature is too high.	Next time set slightly lower oven temperature.
	The baking time is too short.	Next time set a longer baking time and lower oven temperature.
The cake is too dry.	The oven temperature is too low.	Next time set higher oven temperature.
	The baking time is too long.	Next time set shorter baking time.
The cake bakes unevenly.	The oven temperature is too high and the baking time is too short.	Set lower oven temperature and longer baking time.
	The cake batter is not evenly distributed.	Next time spread the cake batter evenly on the baking tray.
The cake is not ready in the baking time specified in a recipe.	The oven temperature is too low.	Next time set a slightly higher oven temperature.

11.6 Baking on one level





 BAKING IN TINS				
		 (°C)	 (min)	
Ring cake / Brioche	True Fan Cooking	150 - 160	50 - 70	1
Madeira cake / Fruit cakes	True Fan Cooking	140 - 160	70 - 90	1
Flan base - short pastry, preheat the empty oven	True Fan Cooking	170 - 180	10 - 25	2
Flan base - sponge cake mixture	True Fan Cooking	150 - 170	20 - 25	2
Cheesecake	Conventional Cooking	170 - 190	60 - 90	1

 CAKES / PASTRIES / BREADS ON BAKING TRAYS				
 Preheat the empty oven unless specified otherwise.				
		 (°C)	 (min)	
Plaited bread / Bread crown, pre- heating is not needed	Conventional Cooking	170 - 190	30 - 40	3
Christstollen	Conventional Cooking	160 - 180	50 - 70	2
Rye bread:	Conventional Cooking	first: 230 then: 160 - 180	20 30 - 60	1
Cream puffs / Eclairs	Conventional Cooking	190 - 210	20 - 35	3
Swiss roll,	Conventional Cooking	180 - 200	10 - 20	3
Cake with crumble topping, preheat- ing is not needed	True Fan Cook- ing	150 - 160	20 - 40	3

 CAKES / PASTRIES / BREADS ON BAKING TRAYS				
 Preheat the empty oven unless specified otherwise.				
		 (°C)	 (min)	
Buttered almond cake / Sugar cakes	Conventional Cooking	190 - 210	20 - 30	3
Fruit flans, pre-heating is not needed	Conventional Cooking	180	35 - 55	3
Yeast cakes with delicate toppings (e.g. quark, cream, custard)	Conventional Cooking	160 - 180	40 - 60	3

 BISCUITS				
 Use the third shelf position.				
		 (°C)	 (min)	
Short pastry / Sponge cake mixture	True Fan Cooking	150 - 160	10 - 20	
Meringues	True Fan Cooking	80 - 100	120 - 150	
Macaroons	True Fan Cooking	100 - 120	30 - 50	
Yeast dough biscuits	True Fan Cooking	150 - 160	20 - 40	
Puff pastries, preheat the empty oven	True Fan Cooking	170 - 180	20 - 30	
Rolls, preheat the empty oven	Conventional Cooking	190 - 210	10 - 25	





11.7 Bakes and gratins





 Use the first shelf position.			
		 (°C)	 (min)
Pasta bake	Conventional Cooking	180 - 200	45 - 60
Lasagne	Conventional Cooking	180 - 200	25 - 40
Vegetables au gratin, preheat the empty oven	Turbo Grilling	160 - 170	15 - 30
Baguettes with melted cheese	True Fan Cooking	160 - 170	15 - 30
Milk rice	Conventional Cooking	180 - 200	40 - 60
Fish bakes	Conventional Cooking	180 - 200	30 - 60
Stuffed vegetables	True Fan Cooking	160 - 170	30 - 60

11.8 Multilevel Baking

Use the function: True Fan Cooking.

For 2 trays use the first and fourth shelf position.

 CAKES / PASTRIES / BREADS ON BAKING TRAYS		
	 (°C)	 (min)
Cream puffs / Eclairs, preheat the empty oven	160 - 180	25 - 45
Dry streusel cake	150 - 160	30 - 45

 BISCUITS		
	 (°C)	 (min)
Short pastry biscuits	150 - 160	20 - 40
Meringues	80 - 100	130 - 170
Macaroons	100 - 120	40 - 80
Yeast dough biscuits	160 - 170	30 - 60
Puff pastries, preheat the empty oven	170 - 180	30 - 50
Rolls	180	20 - 30

11.9 Tips on Roasting

Use heat-resistant ovenware.

Roast lean meat covered.

Roast large meat joints directly in the tray or on the wire shelf placed above the tray.

Put some water in the tray to prevent dripping fat from burning.







Turn the roast after 1/2 - 2/3 of the cooking time.







Roast meat and fish in large pieces (1 kg or more).







Baste meat joints with their own juice several times during roasting.







11.10 Roasting







Use the first shelf position.







 BEEF				
			 (°C)	 (min)
Pot roast	1 - 1.5 kg	Conventional Cooking	230	120 - 150
Roast beef or fillet, rare, preheat the empty oven	1 cm thick	Turbo Grilling	190 - 200	5 - 6
Roast beef or fillet, medium, preheat the empty oven	1 cm thick	Turbo Grilling	180 - 190	6 - 8
Roast beef or fillet, well done, preheat the empty oven	1 cm thick	Turbo Grilling	170 - 180	8 - 10







 PORK				
 Use the function: Turbo Grilling.				
	 (kg)	 (°C)	 (min)	
Shoulder / Neck / Ham joint	1 - 1.5	160 - 180	90 - 120	
Chops / Spare rib	1 - 1.5	170 - 180	60 - 90	
Meatloaf	0.75 - 1	160 - 170	50 - 60	
Pork knuckle, precooked	0.75 - 1	150 - 170	90 - 120	

 VEAL				
 Use the function: Turbo Grilling.				
	 (kg)	 (°C)	 (min)	
Roast veal	1	160 - 180	90 - 120	
Veal knuckle	1.5 - 2	160 - 180	120 - 150	

 LAMB				
 Use the function: Turbo Grilling.				
	 (kg)	 (°C)	 (min)	
Lamb leg / Roast lamb	1 - 1.5	150 - 170	100 - 120	
Lamb saddle	1 - 1.5	160 - 180	40 - 60	

 GAME				
	 (kg)		 (°C)	 (min)
Saddle / Hare leg, preheat the empty oven	1	Conventional Cooking	230	30 - 40
Venison saddle	1.5 - 2	Conventional Cooking	210 - 220	35 - 40
Haunch of venison	1.5 - 2	Conventional Cooking	180 - 200	60 - 90





 POULTRY			
 Use the function: Turbo Grilling.			
	 (kg)	 (°C)	 (min)
Poultry, portions	0.2 - 0.25	200 - 220	30 - 50
Chicken, half	0.4 - 0.5	190 - 210	35 - 50
Chicken, poulard	1 - 1.5	190 - 210	50 - 70
Duck	1.5 - 2	180 - 200	80 - 100
Goose	3.5 - 5	160 - 180	120 - 180
Turkey	2.5 - 3.5	160 - 180	120 - 150
Turkey	4 - 6	140 - 160	150 - 240





 FISH				
	 (kg)		 (°C)	 (min)
Whole fish	1 - 1.5	Conventional Cooking	210 - 220	40 - 60

11.11 Bread Baking





Use the second shelf position.







Preheating is not recommended.







 BREAD		
	 (°C)	 (min)
White bread	180 - 200	40 - 60
Baguette	200 - 220	35 - 45
Brioche	180 - 200	40 - 60
Ciabatta	200 - 220	35 - 45

 BREAD		
	 (°C)	 (min)
Rye bread	190 - 210	50 - 70
Wholemeal bread	180 - 200	50 - 70
Whole grain bread	170 - 190	60 - 90
Bread rolls	190 - 210	20 - 35

11.12 Crispy baking with Pizza Function

 PIZZA		
 Use the first shelf position.		
	 (°C)	 (min)
Tarts	180 - 200	40 - 55
Spinach flan	160 - 180	45 - 60
Quiche lorraine / Swiss flan	170 - 190	45 - 55
Apple pie, covered	150 - 170	50 - 60







 PIZZA		
 Preheat the empty oven before cooking.		
 Use the second shelf position.		
	 (°C)	 (min)
Pizza, thin crust	200 - 230	15 - 20
Pizza, thick crust	180 - 200	20 - 30

 PIZZA		
 Preheat the empty oven before cooking.		
 Use the second shelf position.		
	 (°C)	 (min)
Unleavened bread	230 - 250	10 - 20
Puff pastry flan	160 - 180	45 - 55
Flammkuchen	230 - 250	12 - 20
Pierogi	180 - 200	15 - 25
Vegetable pie	160 - 180	50 - 60

11.13 Grill

Preheat the empty oven before cooking.

Put the pan into the first shelf position to collect fat.





 GRILL				
	 (°C)	 (min) 1st side	 (min) 2nd side	
Roast beef	210 - 230	30 - 40	30 - 40	2
Beef fillet	230	20 - 30	20 - 30	3
Pork loin	210 - 230	30 - 40	30 - 40	2
Veal loin	210 - 230	30 - 40	30 - 40	2
Lamb saddle	210 - 230	25 - 35	20 - 25	3
Whole fish, 0.5 - 1 kg	210 - 230	15 - 30	15 - 30	3 / 4

11.14 Slow Cooking





This function allows you to prepare lean, tender meat and fish. It is not applicable for: poultry, fatty roast pork, pot roast. Food Sensor temperature should not be higher than 65 °C.

1. Sear the meat for 1 - 2 minutes on each side in a pan over high heat.
2. Put the meat in the roasting pan or directly on the wire shelf. Put a tray below the wire shelf to collect fat. Always cook without a lid while using this function.

3. Use Food Sensor.
4. Select the function: Slow Cooking.
You can set the temperature between 80 °C and 150 °C for the first 10 minutes. The default is 90 °C.
Set the temperature for Food Sensor.
5. After 10 minutes, the oven automatically lowers the temperature to 80 °C.

 Set the temperature to 120 °C.			
	 (kg)	 (min)	
Steaks	0.2 - 0.3	20 - 40	3
Fillet of beef	1 - 1.5	90 - 150	3
Roast beef	1 - 1.5	120 - 150	1
Roast veal	1 - 1.5	120 - 150	1

11.15 Frozen Foods





 DEFROSTING				
	 (°C)	 (min)		
Pizza, frozen	200 - 220	15 - 25		2
Pizza American, frozen	190 - 210	20 - 25		2
Pizza, chilled	210 - 230	13 - 25		2
Pizza snacks, frozen	180 - 200	15 - 30		2
French fries, thin	200 - 220	20 - 30		3
French fries, thick	200 - 220	25 - 35		3
Wedges / Croquettes	220 - 230	20 - 35		3
Hash browns	210 - 230	20 - 30		3
Lasagne / Cannelloni, fresh	170 - 190	35 - 45		2
Lasagne / Cannelloni, frozen	160 - 180	40 - 60		2
Baked cheese	170 - 190	20 - 30		3
Chicken wings	190 - 210	20 - 30		2

11.16 Defrost

Remove the food packaging and put the food on a plate.

Use the first shelf position.

Do not cover the food, as this can extend the defrost time.

	 (kg)	 (min) Defrosting time	 (min) Further defrosting time	
Chicken	1	100 - 140	20 - 30	Put the chicken on an upturned saucer in a big plate. Turn halfway through.
Meat	1	100 - 140	20 - 30	Turn halfway through.
Meat	0.5	90 - 120	20 - 30	Turn halfway through.
Trout	0.15	25 - 35	10 - 15	-
Strawberries	0.3	30 - 40	10 - 20	-
Butter	0.25	30 - 40	10 - 15	-
Cream	2 x 0.2	80 - 100	10 - 15	Whip the cream when still slightly frozen in places.
Gateau	1.4	60	60	-

11.17 Preserving

Use only preserve jars of the same dimensions available on the market.

Do not use jars with twist-off and bayonet type lids or metal tins.

Use the first shelf position.

Put no more than six one-litre preserve jars on the baking tray.



Fill the jars equally and close with a clamp.





The jars cannot touch each other.





Put approximately 1/2 litre of water into the baking tray to give sufficient moisture in the oven.

When the liquid in the jars starts to simmer (after approximately 35 - 60 minutes with one-litre jars), stop the oven or decrease the temperature to 100 °C (see the table).

Set the temperature to 160 - 170 °C.

	 (min) Cooking time until simmering
 SOFT FRUIT	
Strawberries / Blueberries / Raspberries / Ripe gooseberries	35 - 45



 STONE FRUIT		
	 (min) Cooking time until simmering	 (min) Continue to cook at 100 °C
Peaches / Quinces / Plums	35 - 45	10 - 15

 VEGETABLES		
	 (min) Cooking time until simmering	 (min) Continue to cook at 100 °C
Carrots	50 - 60	5 - 10
Cucumbers	50 - 60	-
Mixed pickles	50 - 60	5 - 10
Kohlrabi / Peas / Asparagus	50 - 60	15 - 20

11.18 Dehydrating - True Fan Cooking

Cover trays with grease proof paper or baking parchment.





11.19 Food Sensor

 BEEF	 Food core temperature (°C)		
	Rare	Medium	Well done
Roast beef	45	60	70
Sirloin	45	60	70



For a better result, stop the oven halfway through the drying time, open the door and let it cool down for one night to complete the drying.



For 1 tray use the third shelf position.



For 2 trays use the first and fourth shelf position.



 VEGETABLES		
	 (°C)	 (h)
Beans	60 - 70	6 - 8
Peppers	60 - 70	5 - 6
Vegetables for soup	60 - 70	5 - 6
Mushrooms	50 - 60	6 - 8
Herbs	40 - 50	2 - 3



Set the temperature to 60 - 70 °C.



 FRUIT	
	 (h)
Plums	8 - 10
Apricots	8 - 10
Apple slices	6 - 8
Pears	6 - 9



 BEEF	 Food core temperature (°C)		
	Less	Medium	More
Meatloaf	80	83	86



 PORK	 Food core temperature (°C)		
	Less	Medium	More
Ham / Roast	80	84	88
Saddle chop / Pork loin, smoked / Pork loin, poached	75	78	82



 VEAL	 Food core temperature (°C)		
	Less	Medium	More
Roast veal	75	80	85
Veal knuckle	85	88	90



 MUTTON / LAMB	 Food core temperature (°C)		
	Less	Medium	More
Mutton leg	80	85	88
Mutton saddle	75	80	85
Roast lamb / Lamb leg	65	70	75



 GAME	 Food core temperature (°C)		
	Less	Medium	More
Hare saddle / Venison saddle	65	70	75
Hare leg / Hare, whole / Venison leg	70	75	80

 POULTRY	 Food core temperature (°C)		
	Less	Medium	More
Chicken	80	83	86
Duck, whole / half / Turkey, whole / breast	75	80	85
Duck, breast	60	65	70

 FISH (SALMON, TROUT, ZANDER)	 Food core temperature (°C)		
	Less	Medium	More
Fish, whole / large / steamed / Fish, whole / large / roasted	60	64	68

 CASSEROLES - PRE-COOKED VEGETABLES	 Food core temperature (°C)		
	Less	Medium	More
Zucchini casserole / Broccoli casserole / Fennel casserole	85	88	91



 CASSEROLES - SAVOURY	 Food core temperature (°C)		
	Less	Medium	More
Cannelloni / Lasagne / Pasta bake	85	88	91

 CASSEROLES - SWEET	 Food core temperature (°C)		
	Less	Medium	More
White bread casserole with / without fruit / Rice porridge casserole with / without fruit / Sweet noodle casserole	80	85	90

11.20 Moist Fan Baking - recommended accessories

Use the dark and non-reflective tins and containers. They have better heat

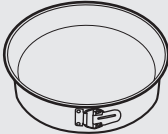

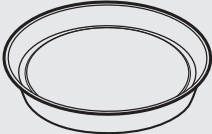
absorption than the light colour and reflective dishes.

			
Pizza pan	Baking dish	Ramekins	Flan base tin
Dark, non-reflective 28 cm diameter	Dark, non-reflective 26 cm diameter	Ceramic 8 cm diameter, 5 cm height	Dark, non-reflective 28 cm diameter

11.21 Moist Fan Baking







For the best results follow suggestions listed in the table below.







Use the third shelf position.







	 (°C)	 (min)
Pasta gratin	200 - 220	45 - 55
Potato gratin	180 - 200	70 - 85
Moussaka	170 - 190	70 - 95
Lasagne	180 - 200	75 - 90
Cannelloni	180 - 200	70 - 85
Bread pudding	190 - 200	55 - 70
Rice pudding	170 - 190	45 - 60
Apple cake, made of sponge cake mixture (round cake tin)	160 - 170	70 - 80
White bread	190 - 200	55 - 70







11.22 Information for test institutes







Tests according to: EN 60350, IEC 60350.

 BAKING ON ONE LEVEL. Baking in tins					
		 (°C)	 (min)		
Fatless sponge cake	True Fan Cooking	140 - 150	35 - 50	2	
Fatless sponge cake	Conventional Cooking	160	35 - 50	2	
Apple pie, 2 tins Ø20 cm	True Fan Cooking	160	60 - 90	2	
Apple pie, 2 tins Ø20 cm	Conventional Cooking	180	70 - 90	1	

 BAKING ON ONE LEVEL. Biscuits					
 Use the third shelf position.					
		 (°C)	 (min)		
Short bread / Pastry strips	True Fan Cooking	140	25 - 40	2	
Short bread / Pastry strips, preheat the empty oven	Conventional Cooking	160	20 - 30	2	
Small cakes, 20 per tray, preheat the empty oven	True Fan Cooking	150	20 - 35	2	
Small cakes, 20 per tray, preheat the empty oven	Conventional Cooking	170	20 - 30	2	

 MULTILEVEL BAKING. Biscuits					
		 (°C)	 (min)		
				2 posi- tions	3 posi- tions
Short bread / Pastry strips	True Fan Cooking	140	25 - 45	1 / 4	1 / 3 / 5

 MULTILEVEL BAKING. Biscuits					
		 (°C)	 (min)	 2 posi- tions 3 posi- tions	
Small cakes, 20 per tray, preheat the empty oven	True Fan Cooking	150	23 - 40	1 / 4	-

 GRILL					
 Preheat the empty oven for 5 minutes.					
 Grill with the maximum temperature setting.					
		 (min)			
Toast	Grill	1 - 3		5	
Beef steak, turn halfway through	Grill	24 - 30		4	

12. CARE AND CLEANING



WARNING!

Refer to Safety chapters.

12.1 Notes on cleaning



Cleaning Agents

Clean the front of the oven with a soft cloth with warm water and a mild cleaning agent.

To clean metal surfaces, use a dedicated cleaning agent.

Clean stubborn stains with a special oven cleaner. Do not apply oven cleaner on the catalytic surfaces.



Everyday Use

Clean the oven cavity after each use. Fat accumulation or other food remains may cause fire. The risk is higher for the grill pan.

Dry the cavity with a soft cloth after each use.



Accessories

Clean all accessories after each use and let them dry. Use a soft cloth with warm water and a cleaning agent. Do not clean the accessories in a dishwasher.

Do not clean the non-stick accessories using aggressive agents, sharp-edged objects or in a dishwasher.

12.2 How to remove: shelf supports

To clean the oven, remove the shelf supports.



CAUTION!

Be careful when you remove the shelf supports.

1. Pull the front of the shelf support away from the side wall.

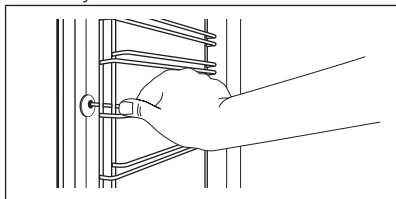

2. Pull the rear end of the shelf support away from the side wall and remove it.

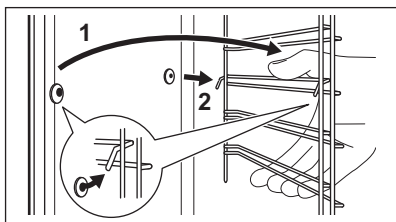

Install the removed accessories in the opposite sequence.

12.3 Catalytic cleaning

The cavity is coated with a catalytic enamel. It absorbs fat.

Before you turn on the Catalytic cleaning:

- remove all the accessories and removable shelf supports.
- clean the oven floor with warm water and mild detergent.
- clean the inner door glass with warm water and soft cloth.

The Catalytic cleaning cannot start:

- if the shelf supports are not removed.
- if the oven door are not closed.

1. Set function:Catalysis.

2. Press **OK** to confirm.

The display shows the time of day and the duration of cleaning.

You cannot change the duration of the Catalytic cleaning. You can delay the start of the cleaning with the function: End Time.

The signal sounds at the end of cleaning. The oven turns off.

3. Press any sensor field to stop the signal.

4. When the oven cools down, clean the cavity with a wet soft cloth.

Spots or discolouration of the catalytic coating have no effect on Catalytic cleaning.

12.4 How to remove: grill



WARNING!

There is a risk of burns.

1. Turn off the oven. Make sure that the oven is cold.
2. Remove the shelf supports.

3. Hold the grill with two hands at the front.
4. Grab the grill corners. Pull it forwards against the spring pressure and out of two holders.

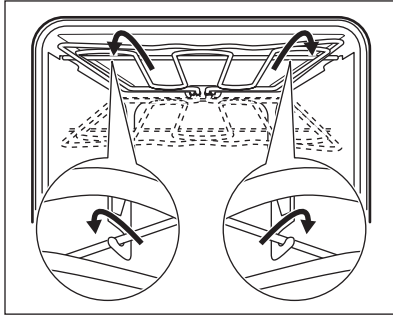

The grill folds down.

5. Clean the oven ceiling with warm water, a soft cloth and a mild detergent. Let it dry.
6. Install the grill in the opposite sequence.
7. Install the shelf supports.

12.5 Removing and installing the door

You can remove the door and the internal glass panels to clean it. The number of glass panels is different for different models.



WARNING!
The door is heavy.

1. Open the oven door fully.
2. Fully press the clamping levers (A) on the two door hinges.

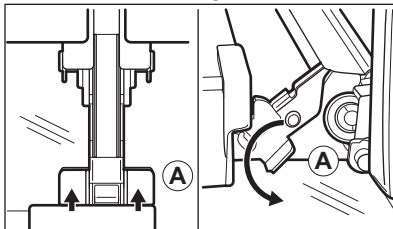

3. Close the oven door to the first opening position (approximately 70° angle).
4. Hold the door with one hand on each side and pull it away from the oven at an upwards angle.

5. Put the door with the outer side down on a soft cloth on a stable surface.
6. Hold the door trim (B) on the top edge of the door at the two sides and push inwards to release the clip seal.

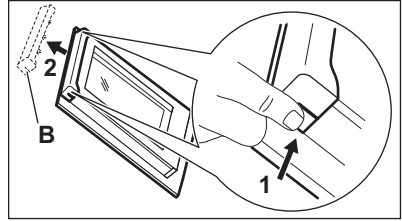

7. Pull the door trim to the front to remove it.
8. Hold the door glass panels on their top edge one by one and pull them up out of the guide.

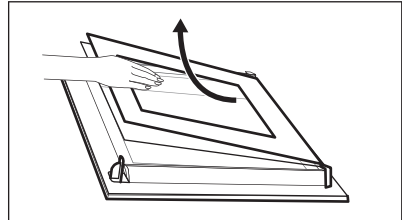

9. Clean the glass panel with water and soap. Dry the glass panel carefully. When the cleaning is completed, do the above steps in the opposite sequence. Install the smaller panel first, then the larger and the door.



WARNING!
Make sure that the glasses are inserted in the correct position otherwise the surface of the door may overheat.

12.6 How to replace: Lamp



WARNING!
Risk of electric shock.
The lamp can be hot.

1. Turn off the oven. Wait until the oven is cold.
2. Disconnect the oven from the mains.
3. Put a cloth on the bottom of the cavity.

The top lamp

1. Turn the lamp glass cover to remove it.

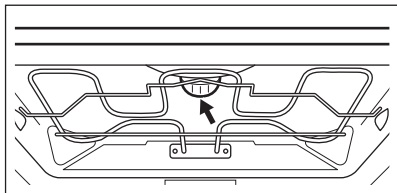

2. Clean the glass cover.
3. Replace the lamp with a suitable 300 °C heat-resistant lamp.
4. Install the glass cover.

The side lamp

1. Remove the left shelf support to get access to the lamp.
2. Use a narrow, blunt object (e.g. a teaspoon) to remove the glass cover.

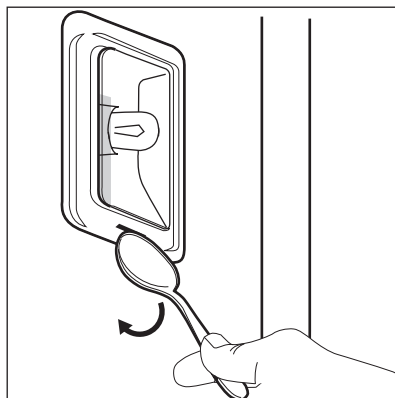

3. Clean the glass cover.
4. Replace the lamp with a suitable 300 °C heat-resistant lamp.
5. Install the glass cover.
6. Install the left shelf support.

13. TROUBLESHOOTING



WARNING!
Refer to Safety chapters.

13.1 What to do if...

Problem	Possible cause	Remedy
You cannot activate or operate the oven.	The oven is not connected to an electrical supply or it is connected incorrectly.	Check if the oven is correctly connected to the electrical supply (refer to the connection diagram if available).
The oven does not heat up.	The oven is turned off.	Turn on the oven.
The oven does not heat up.	The clock is not set.	Set the clock.
The oven does not heat up.	The necessary settings are not set.	Make sure that the settings are correct.
The oven does not heat up.	The automatic switch-off is on.	Refer to "Automatic switch-off".
The oven does not heat up.	The Child Lock is on.	Refer to "Using the Child Lock".

Problem	Possible cause	Remedy
The oven does not heat up.	The fuse is blown.	Make sure that the fuse is the cause of the malfunction. If the fuse is blown again and again, contact a qualified electrician.
The lamp does not operate.	The lamp is defective.	Replace the lamp.
The core temperature sensor does not operate.	The plug of the core temperature sensor is not correctly installed into the socket.	Put the plug of the core temperature sensor as far as possible into the socket.
The display shows F111.	The plug of the core temperature sensor is not correctly installed into the socket.	Put the plug of the core temperature sensor as far as possible into the socket.
The display shows an error code that is not in this table.	There is an electrical fault.	<ul style="list-style-type: none"> • Turn off the oven with the house fuse or the safety switch in the fuse box and turn it on again. • If the display shows the error code again, contact the Customer Care Department.
Steam and condensation settle on the food and in the cavity of the oven.	You left the dish in the oven for too long.	Do not leave the dishes in the oven for longer than 15 - 20 minutes after the cooking process ends.
The appliance is activated and does not heat up. The fan does not operate. The display shows " Demo ".	The demo mode is activated.	Refer to "Basic Settings" in "Daily use" chapter.

13.2 Service data

If you cannot find a solution to the problem yourself, contact your dealer or an Authorised Service Centre.

The necessary data for the service centre is on the rating plate. The rating plate is

on the front frame of the oven cavity. Do not remove the rating plate from the oven cavity.

We recommend that you write the data here:	
Model (MOD.)
Product number (PNC)
Serial number (S.N.)

14. ENERGY EFFICIENCY

14.1 Product Information and Product Information Sheet*

Supplier's name	AEG	
Model identification	BCE742220B 944188221 BCK742220M 944187833	
Energy Efficiency Index	81.2	
Energy efficiency class	A+	
Energy consumption with a standard load, conventional mode	1.09 kWh/cycle	
Energy consumption with a standard load, fan-forced mode	0.69 kWh/cycle	
Number of cavities	1	
Heat source	Electricity	
Volume	71 l	
Type of oven	Built-In Oven	
Mass	BCE742220B	35.0 kg
	BCK742220M	36.0 kg

* For European Union according to EU Regulations 65/2014 and 66/2014.

For Republic of Belarus according to STB 2478-2017, Appendix G; STB 2477-2017, Annexes A and B.

For Ukraine according to 568/32020.

Energy efficiency class is not applicable for Russia.

EN 60350-1 - Household electric cooking appliances - Part 1: Ranges, ovens, steam ovens and grills - Methods for measuring performance.

14.2 Energy saving



The oven contains features which help you save energy during everyday cooking.

Make sure that the oven door is closed properly when the oven operates. Do not open the door too often during cooking. Keep the door gasket clean and make sure it is well fixed in its position.

Use metal cookware to improve energy saving.

When possible, do not preheat the oven before cooking.

Keep breaks between baking as short as possible when you prepare a few dishes at one time.

Cooking with fan

When possible, use the cooking functions with fan to save energy.

Residual heat

If a programme with the Duration or End Time selection is activated and the cooking time is longer than 30 minutes, the heating elements automatically turn off earlier in some oven functions.

The fan and lamp continue to operate. When you turn off the oven, the display

shows the residual heat. You can use that heat to keep the food warm.

When the cooking duration is longer than 30 minutes, reduce the oven temperature to minimum 3 - 10 minutes before the end of cooking. The residual heat inside the oven will continue to cook.

Use the residual heat to warm up other dishes.

Keep food warm

Choose the lowest possible temperature setting to use residual heat and keep a meal warm. The residual heat indicator or temperature appears on the display.

Cooking with the lamp off

Turn off the lamp during cooking. Turn it on only when you need it.

Moist Fan Baking

Function designed to save energy during cooking.

When you use this function the lamp automatically turns off after 30 seconds. You may turn on the lamp again but this action will reduce the expected energy savings.

15. ENVIRONMENTAL CONCERNS

Recycle materials with the symbol . Put the packaging in relevant containers to recycle it. Help protect the environment and human health by recycling waste of electrical and electronic appliances. Do not dispose of

appliances marked with the symbol  with the household waste. Return the product to your local recycling facility or contact your municipal office.

www.aeg.com/shop



867 353877-A-392019



AEG